

EN

# Instruction manual

# HydroSMART

Smart technology for a soft water

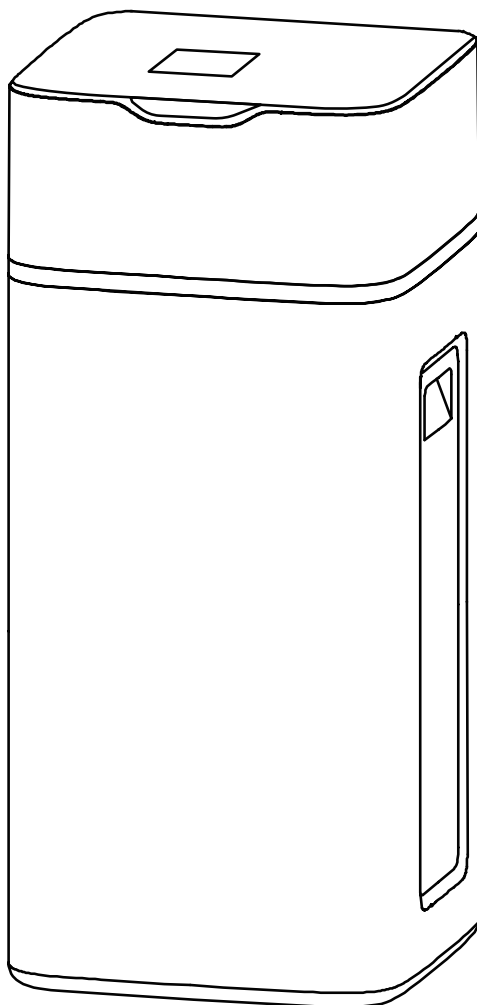

**Water Softener**

---

**AQUAVIE**<sup>®</sup>  
TECHNOLOGIE

Read through all the instructions before installing and using the appliance.

# Content

<b>Technical Data</b>	<b>p 24</b>
<b>Introduction</b>	<b>p 25 - 26</b>
<i>Working Principle</i>	<i>p 25</i>
<i>Features</i>	<i>p 25</i>
<i>Description On The Control Panel</i>	<i>p 26</i>
<b>Before Use</b>	<b>p 27 - 31</b>
<i>Checking The Appliance</i>	<i>p 27</i>
<i>Installing The Appliance</i>	<i>p 27</i>
<i>Wateryway Connection Instruction</i>	<i>p 27</i>
<i>Circuit Connection Instruction</i>	<i>p 28</i>
<i>Setting Up The Appliance</i>	<i>p 28</i>
<i>Basic Settings</i>	<i>p 28</i>
<i>Other Initial Settings</i>	<i>p 29</i>
<i>User Mode</i>	<i>p 30</i>
<i>Introduction Of The Brine Valve</i>	<i>p 30</i>
<i>Introduction Of The Bypass Valve</i>	<i>p 30</i>
<i>Introduction Of The Mixing Button</i>	<i>p 31</i>
<b>Trial Running</b>	<b>p 32 - 33</b>
<b>Safety</b>	<b>p 34 - 35</b>
<b>Trouble Shooting</b>	<b>p 36 - 38</b>

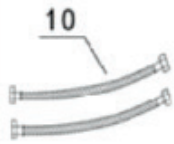
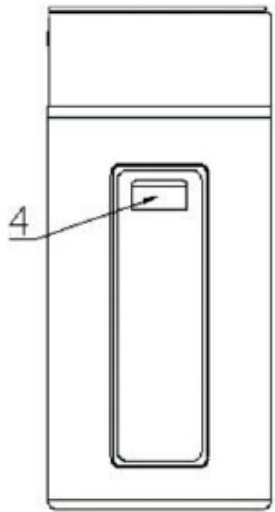
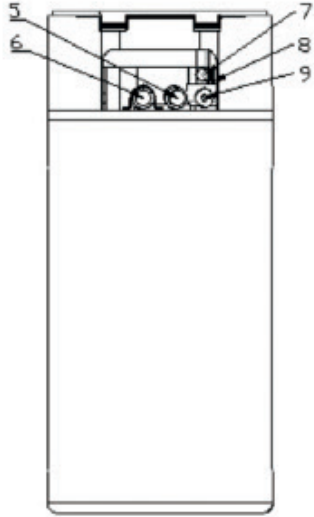
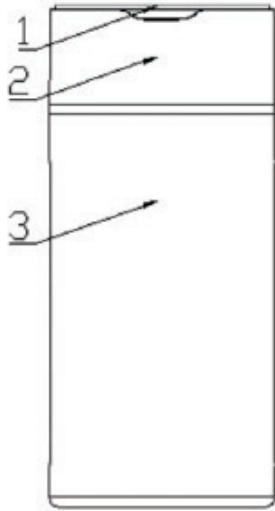

- 1. Lid
- 2. Cover
- 3. Tank
- 4. Handle
- 5. Inlet Water Port
- 6. Outlet Water Port
- 7. Brine Line Connector
- 8. Power port
- 9. Drain
- 10. Stainless Steel Tube

# Technical Data

Item Parameters	Parameters	
	HydroSmart 10	HydroSmart 20
Voltage	100-240V~50/60HZ	
Inlet/Outlet port	3/4" BSPT	
Water treatment capacity	1500	2500
Type of Resin	Cationic resin	
Resin content (L)	10	20
Working water pressure (MPa)	0.15~0.6	
Max water pressure (MPa)	≤0.8	
Temperature (°C)	5~50	
Relative humidity	≤90%(25°C)	
Raw water hardness	≤6 mmol/L(CaCO <sub>3</sub> )	
Turbidity	≤2FTU	
Free Chlorine	≤0.1mmol/L	
Iron <sup>2+</sup>	≤0.3mmol/L	
Display mode	LCD display	
Regenerate time	2:00am(Adjustable)	
Backwash time (min)	10~15 (Higher turbidity, longer backwash time)	
Brine & Slow Rinse time (min)	30~65	
Brine refill time (min) 5 10	5	10
Fast rinse time (min) 8~12	8~12	
Salt refill (Kg)	The height of salt should be more than 2/3 height of softener. Please refer to "NOTICE 3"	
Salt consumption	160~240 (according to raw water quality)	
Hardness of output water	0.03 mmol/L (CaCO <sub>3</sub> )	
Water Capacity Per Cycle (L)	1500 (output water hardness is 4mmol/L (CaCO <sub>3</sub> ))	3000 (output water hardness is 4mmol/L (CaCO <sub>3</sub> ))
Running noise	<50dB	
G.W./N.W. (Kg)	27.6/23.1	37.4/31.2
Softener dimension (mm)	L390*W337*H755	L390*W337*H1055
Packing dimension (mm)	L430*W430*H1035	L430*W430*H1328

# Introduction

Thank you for choosing the HydroSMART water softener.  
We hope you enjoy using your new appliance.

Take a few minutes to read these instructions. This will avoid all unnecessary risks and damage to the appliance.

## Working Principle

Ion exchange technology is applied to the water softener. It can realize the purpose of wiping off the lime scale (Calcium carbonate and magnesium carbonate) through replacing the calcium and magnesium ions in hard water with the sodium ions.

Our HydroSMART is designed as an automatic and intelligent product. With the food-grade cationic resin which is of high flow rate and excellent softening performance, HydroSMART can reduce the content of calcium and magnesium in tap water efficiently.

After the resin is saturated, the regeneration function will recover the resin's service life.



## Features

- Automatic operation

HydroSMART automatically calculates water treatment volume according to tap water hardness set up by user and shows it on LCD display. When the volume runs out, system automatically starts regeneration at regeneration time (trig time).









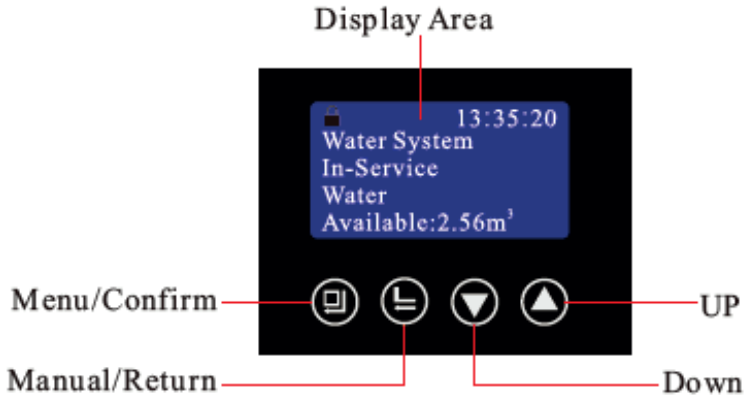













- Multi-Language Options

There are 11 language options in Snow Tower: English, Spanish, Chinese, French, Italian, Russian, German, Turkish, Polish, Catalan and Slovak.

After plug in and light on for 6 seconds, press and hold both  and  for over 5 seconds to enter into the language selection interface.

## Description On The Control Panel



Button	Operation
 Button lock indicator	Light on, indicate the buttons are locked. During this status, press on any single Button will not work. (Under any status, if no operation in one minute, will light on and lock the buttons) Solution : press and hold both  and  for 5 seconds until the  light off.
 Menu/Confirm button	In menu mode, press  and then enter program display mode to view all values. In program display mode, press  and enter program set mode to adjust all values. Press  after all programs are set, and then the sound "di" means that all settings are done and returning to program display mode.
 Manual/Return Button	Press  in any status, it can proceed to next step immediately. (Example: press  in Service status, it will start Regeneration instantly; press  in Backwash status, it will end backwash and go to Brine & Slow Rinse at once.) Press  in program set mode, it will return to Menu. Press  in Program set mode, it will return to program display mode. Press  while adjusting the value, it will return to program display mode directly without saving value.
 Down & Up button	In program display mode, press  or  to view all values. In program set mode, press  or  to adjust values. Press and hold both  and  for 5 seconds to unlock all the buttons.

# Before Use

## Checking the appliance

After removing the packaging, make sure the product is complete and undamaged and all accessories are present.

Do not use the appliance if it is obviously damaged and contact your local customer services.

## Installing the appliance

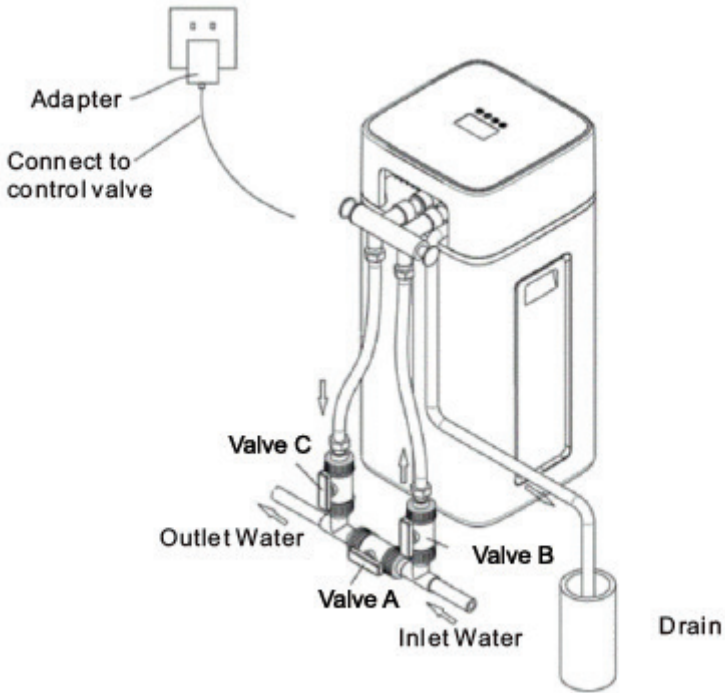

### - Waterway connection instruction

Connect valve A, B, C, inlet and outlet tubes as well as the drain outlet to the digital control valve according to the diagram above. If repairs are required, please turn on valve A and turn off valve B.

During daily use, please turn on valve B and C, and turn off valve A.

Please note: Valve A, B, C are not included in our standard accessory kit.





















## - Circuit connection instruction

Check that the main power supply voltage corresponds to the value indicated in the TECHNICAL DATA mentioned in previous chapter.







Connect the appliance to an efficiently earthed and correctly installed socket. If the power socket does not match the plug of the water softener, have the socket replaced with a suitable type by a qualified professional.

## Setting up the appliance

### - Basic Settings

Item	Parameter Set Range	Factory Default	Process Steps	Symbol
Time of Day	00:00-23:59	Current Value	When  light on, press and hold  and  for 5 seconds until light off.	<div style="border: 1px solid black; padding: 5px; margin-bottom: 5px;">M. Softener Para. Set &gt;&gt; Set Time of Day Set Regen. Time Set Water Hardness</div> <div style="text-align: center; margin-bottom: 5px;">LR1</div> <div style="border: 1px solid black; padding: 5px; margin-bottom: 5px;">Set Time of Day 12:30</div> <div style="text-align: center;">LR2</div>
			1. Press  and enter the interface of "M. Softener Para. Set" as LR1. The item of "Set Time of Day" will be selected by system automatically.	
			2. Then press  and the setting interface will display as LR2; the hour value "12" flashes. Press  or  to adjust the hour value.	
			3. Then press  again, the minute value "30" flashes. Press  or  to adjust the minute value.	
			4. At last, press  and hear the sound "di", the setting is done.	
Regeneration Time	00:00-23:59	2:00	1. Press  and enter the interface of "M. Softener Para. Set" as LR1.	<div style="border: 1px solid black; padding: 5px; margin-bottom: 5px;">Set Regen. Time 02:30</div> <div style="text-align: center;">LR3</div>
			2. Press  and select the item of "Set Regen.Time"; then press  , the setting interface will display as LR3; hour value "02" flashes. Press  or  to adjust the hour value.	
			3. Press  , the minute value "00" flashes. Press  or  to adjust the minute value.	
			4. At last, press  and hear the sound "di", the setting is done.	



Item	Parameter Set Range	Factory Default	Process Steps	Symbol
Raw Water Hardness	50-999mg/L	150mg/L	1. Press  and enter the interface of "M. Softener Para. Set" as LR1.	<div style="border: 1px solid black; padding: 5px; text-align: center;">           Set Water Hardness 150mg/L         </div> LR4
			2. Press  twice and select the item of «Set Water Hardness» ; then press  , the setting interface will display as LR4; Hardness value "150" flashes. Press  or  to adjust the hardness value.	
			3. At last, press  and hear the sound «di», the setting is done.	

Note: After source water hardness is set, operating screen will show the total or the remaining treatment volume. User can set source water hardness to adjust the treatment volume in each production cycle, for example: to reduce source water hardness a little bit can increase the treatment volume.

### - Other initial settings

Item Parameters	Parameters	
	HydroSmart 10	HydroSmart 20
Mode	Softener	
Valve model	F79	
Control type	Meter type(adjustable)	
Resin Volume	10L	20L
Brine refill type	Up flow(adjustable)	
Interval regeneration time	30days (adjustable)	40days (adjustable)
Backwash time	10minutes(adjustable)	15minutes(adjustable)
Brine and slow rinse time	30minutes(adjustable)	60minutes(adjustable)
Brine refilling time	5minutes(adjustable)	10minutes(adjustable)
Fast rinse time	8minutes (adjustable)	12minutes(adjustable)

Note: These settings are already done in factory. All the parameters are just for reference. The most suitable time for regeneration, backwash and rinse depends on resin quality. Consult your retailer or customer services if reset is required.

## - User Mode

After power on, L1 (see below) interface will display for 3 seconds, and then the system enters into user mode.

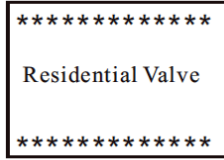

L1

Softener process display

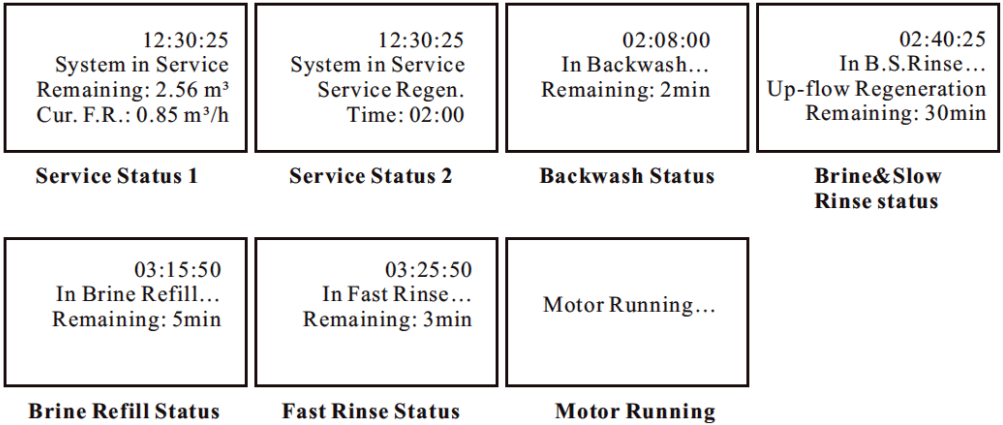

Working process: Service → Backwash → Brine & Slow Rinse → Brine Refill → Fast Rinse → Service (cycle repeats).

## - Introduction of the Brine Valve

In brine and slow rinse status, with the floating switch, the brine valve can prevent the air from being inhaled which may affect the regeneration and normal operation of this system.

That is, the brine valve has the function of air check.

In brine refill status, the brine valve can control the volume of refilling water by controlling the position of float switch.

## - Introduction of the Bypass Valve

When the piston is pushed to the position of inlet and outlet, the valve is in service status; when it is in bypass position, the valve is in bypass status and water does not pass through the control valve. The control valve and bypass valve are of quick fitting design, perfectly sealed and easy to install. (Please refer to the pictures below)

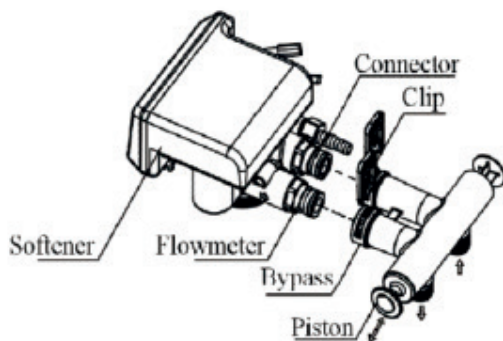
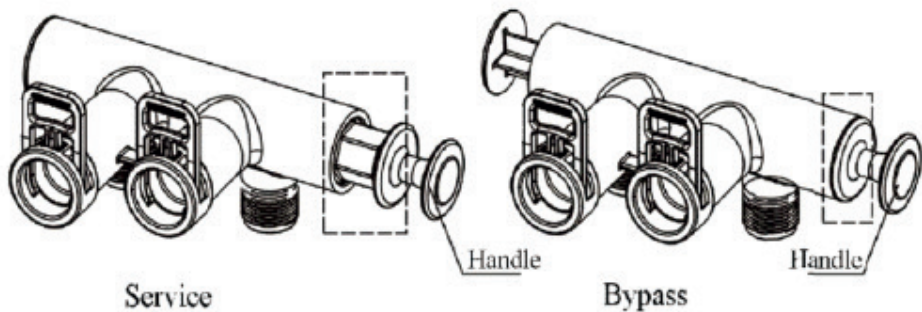

### - Introduction of the Mixing Button

If the users think the hardness of outlet water is too low, they can adjust the target hardness by adjusting the mixing button.

Procedure: Anticlockwise rotate the adjusting bolt (please refer to the picture below). The wider the angle is, the higher outlet water hardness will be.

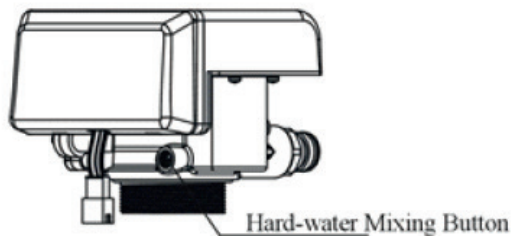

# Trial Running

After installing the water softener as well as setting up the relevant parameters, please conduct a trial running.

Procedures are as below:

- Add industrial salt to over 2/3 high as the water softener and manually fill in enough water to dissolve all the salt (please refer to the chart below) to make saturated brine solution (26%).

Item No.	HydroSmart 10	HydroSmart 20
Water (L)	5	9

- Plug in and press  to enter the Backwash status. Open the inlet valve slowly up to 1/4" of fully open position (DO NOT open the inlet valve too fast, otherwise the appliance may be damaged and resin may run off) to let out all the air in FRP tank. User will hear the sound of air-out from the drain pipeline during this process. After all air is out, fully open the inlet valve and backwash for 2-3 minutes to flush the resin and drain out the impurity and broken resin granulars.

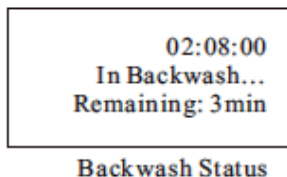

- Press  and end the Backwash Status. Turn the control valve to Brine & Slow Rinse. Under this status, the brine solution will enter into the FRP resin tank for resin regeneration. After that, the brine valve closes and starts a 15-minute slow rinse which removes the spare brine solution. The whole brine & slow rinse process takes about 40 minutes.

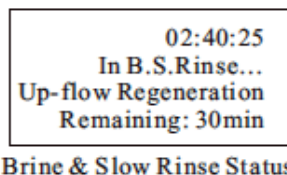

- Press  and end the Brine & Slow Rinse Status. Turn the control valve to Brine Refill to add more water to dissolve the salt. When time is up or the water level reaches the height in initial setting, this status ends. The new saturated brine solution is for resin regeneration next time.

03:15:50  
In Brine Refill...  
Remaining: 5 min

**Brine Refill status**

- Press  and end the Brine Refill status. Turn the control valve to Fast Rinse status to remove the remaining brine solution in FRP tank and compact the resin to reach the best performance of softening. This process takes about 7 minutes.

03:25:50  
In Fast Rinse...  
Remaining: 3 min

**Fast Rinse Status**

- Press  and end the Fast Rinse status. Turn the control valve to Service status and start running.

12:30:25  
System in Service  
Remaining: 2.56 m<sup>3</sup>  
Cur. F.R.: 0.85 m<sup>3</sup>/h

**Service Status**

Note: Under regeneration process, no softened water will be output. The appliance operates automatically according to initial setting. Press  to end a certain process in advance.

- During the trial running, check all the ports, pipes and connections to see if there is any media or liquid leakage.

- Time for backwash, brine & slow rinse, brine refill and fast rinse is initially set in factory. Consult your retailer or customer services if reset is required.

- Under normal operation, user does not need to operate anything except for adding a certain amount of salt into the brine tank if there is no enough salt.

# Safety

- This is an electrical appliance and may cause electric shock. Therefore user should follow the safety warnings below:
- Consult a professional personnel to install, set and trial run this appliance.
- Keep this appliance and all the packaging away from children.
- If source water quality does not meet the Municipal Water Standard, pre-treatment is necessary
- During operation, user should check the salt content in the brine tank to ensure enough salt supply. Every time adding the salt, make sure it's to over 2/3" high as the water softener. When the salt content is less than 1/3" high as the water softener, it's time to add salt. Please refer to the pictures below.

Note: It takes at least 6 hours to dissolve all the salt to saturation. The salt used in water softener should be the coarse salt in granular. DO NOT use the refined or edible salt.

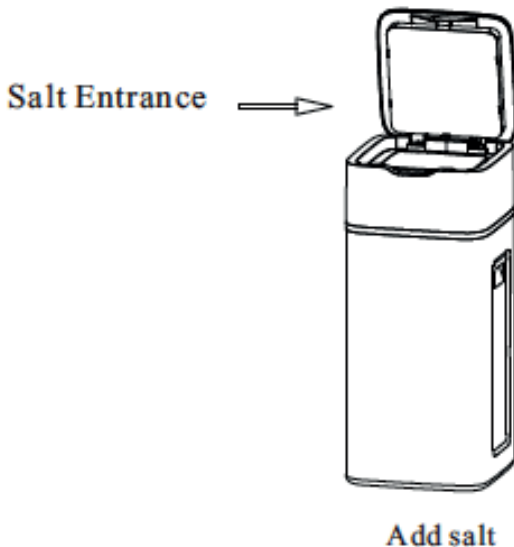

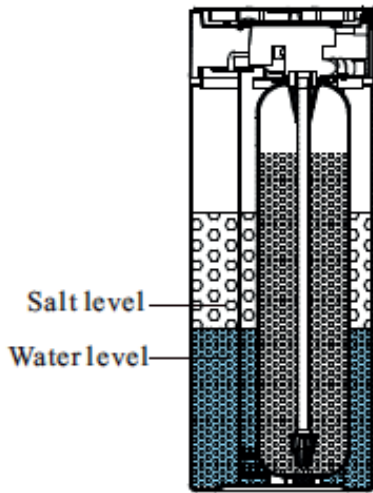

Salt level above water level

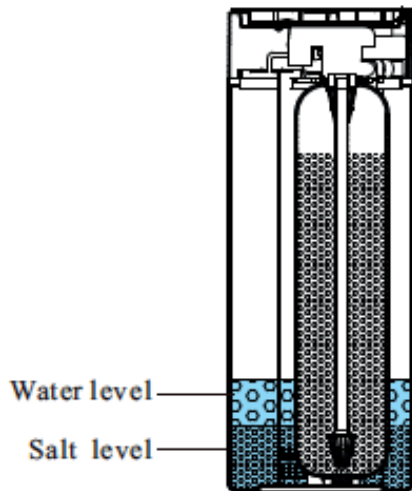

Salt level below water level

- During first operation or the appliance hasn't been used for a long time, it's normal to see yellow liquid flowing out when running the appliance. A 2-3 minute rinse can solve this problem.

- Sometimes salt at the bottom of brine tank cannot be dissolved and forms into salt bridge. User should check and mash it to reach the best performance of resin regeneration and softening.

- Operate this appliance under temperature 5~50℃ and water pressure 0.15~0.6MPa.

- If the appliance won't be used for a long time or the pressure of the inlet water is unstable, cut off the water and power supply; before putting it into use again, please conduct a regeneration process by manual operation to ensure the quality of softened water.

- Be careful of the water hammer effect. DO NOT open or close the valve too fast. DO NOT start and shut off the pump constantly.

Note: The inlet water pressure changes during the day (Normally the pressure at night is higher than that in day time.). Pay attention to each connection to check if there is any leakage in the first two days after appliance is installed.

# Trouble Shooting

Problem	Cause	Correction
1. Softener fails to regenerate.	A. Electrical service to unit has been interrupted.	A. Assure permanent electrical service (check fuse, plug, pull chain or switch).
	B. Regeneration cycles are set incorrectly.	B. Reset regeneration cycles.
	C. Control valve is defective.	C. Replace the control valve.
	D. Motor fails to work.	D. Replace the motor.
2. Regeneration time is not correct.	A. Time of Day is set incorrectly.	A. Check program and reset Time of Day.
	B. Power failure more than 3 days, and Time of Day is wrong.	B. Reset Time of Day.
3. Softener supplies hard water.	A. Bypass valve is open or leaking.	A. Close or repair bypass valve.
	B. No salt in brine tank.	B. Add salt to brine tank and maintain salt level above water level.
	C. Injector plugged.	C. Change or clean injector.
	D. Insufficient water flow into brine.	D. Check brine tank refill time.
	E. O-ring on riser pipe leaks.	E. Make sure riser pipe is not cracked. Check o-ring and tube pilot.
	F. Internal parts of the control valve leak.	F. Repair or replace the control valve.
	G. Regeneration cycles are set incorrectly.	G. Set correct regeneration cycles in the program.
	H. Shortage of resin.	H. Add resin to mineral tank and check why the resin leaks.
	I. Bad quality of feed water or turbine blocked.	I. Reduce the inlet turbidity, clean or replace the turbine.
4. Softener fails to draw brine	A. Inlet pressure is too low.	A. Increase the inlet pressure.
	B. Brine line is plugged.	B. Clean brine line.
	C. Brine line leaks.	C. Replace brine line.
	D. Injector is plugged or broken.	D. Clean or replace new parts.
	E. Internal parts of the control valve leak.	E. Replace the control valve.
	F. Drain outlet is plugged.	F. Clean drain outlet.



<b>Problem</b>	<b>Cause</b>	<b>Correction</b>
5. Too much salt consumption.	A. Too much water in brine tank.	A. See solution of problem No. 6
6. Too much water in brine tank or water overflows.	A. Overlong refilling time.	A. Reset correct refilling time.
	B. Remain too much water after brine.	B. Check the injector and make sure no stuff remains in the brine pipe.
	C. Foreign material in brine valve and plug drain outlet.	C. Clean brine valve and brine line.
	D. No float switch and power fails in Brine Status.	D. Stop water supply and restart the power. Install the float switch.
	E. Refill breaks down.	E. Repair or replace the float switch.
7. Pressure loss or rust in pipeline.	A. Iron in the water supply pipes.	A. Clean the water supply pipes.
	B. Iron in the softener.	B. Clean the control valve, add resin cleaning chemical, and increase frequency of regeneration.
	C. Resin is polluted.	C. Check the Backwash, Brine and Refill. Increase the frequency of regeneration and extend the time of backwash.
	D. Insufficient water flow into brine.	D. Install iron removal equipment before the water softener.
8. Resin exits in drain outlet.	A. Air in water softener.	A. Remove the air in water softener.
	B. Bottom strainer is broken.	B. Replace new strainer.
	C. Too much water outlet in Backwash.	C. Check and set correct outlet flow rate.
9. Control valve cycles continuously.	A. Locating signal wiring breaks down.	A. Check and re-connect locating signal wiring.
	B. Control valve is defective.	B. Replace the control valve.
	C. Foreign material stuck the driving gear.	C. Take out foreign material.
10. Drain flows continuously.	A. Internal parts of the control valve leak.	A. Check and repair the control valve or replace it.
	B. Power supply breaks down during Backwash or Fast Rinse.	B. Adjust valve to service status or turn off bypass. Start the system when power supply is available.

<b>Problem</b>	<b>Cause</b>	<b>Correction</b>
11. Interrupted or irregular brine.	A. Low or unstable inlet water pressure.	A. Increase water pressure
	B. Injector is plugged or defective.	B. Clean or replace the injector.
	C. Air in resin tank.	C. Check and find out the reason.
12. Water flow out from drain or brine pipe after regeneration.	A. Foreign material in control	A. Clean foreign material in the control valve
	B. Hard water mixed in valve body.	B. Change valve core or sealing ring.
	C. Water pressure is too high, therefore the control valve cannot reach the right status.	C. Reduce water pressure or use pressure release function.
	D. Under the Backwash status, the outlet line and brine line are connected.	D. Install a check valve, solenoid valve before outlet or install a liquid level controller in the brine tank.
13. Salt water in softened water.	A. Foreign material in injector or injector fails to work.	A. Clean and repair the injector.
	B. Brine valve cannot be shut off.	B. Repair brine valve and clean it.
	C. Time of fast rinse is too short.	C. Extend fast rinse time.
14. Unit capacity decreases.	A. Unit fails to regenerate or regeneration process is operated incorrectly.	A. Regenerate according to the correct operation requirement.
	B. Resin is polluted.	B. Increase backwash flow rate and time, clean or change resin.
	C. Incorrect salt setting.	C. Re-adjust the brine drawing time.
	D. Incorrect water softener setting	D. According to the test of outlet water, recount and reset the regeneration cycle.
	E. Raw water quality deteriorates.	E. Regenerate unit by manual temporarily, then reset regeneration cycle.
	F. Turbine or flow meter is stuck.	F. Disassemble flow meter and clean it or replace a new turbine.

**AQUAVIE<sup>®</sup>**  
TECHNOLOGIE



# AQUAVIE®

TECHNOLOGIE

